

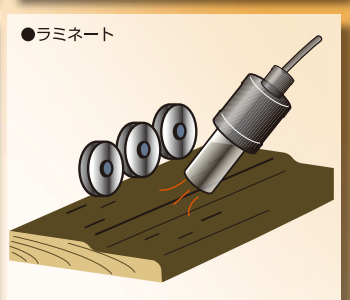

PARK-HEAT

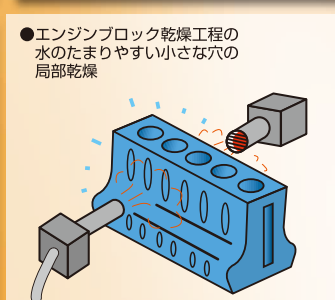
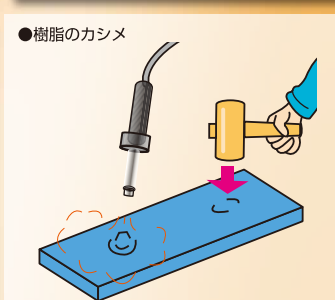
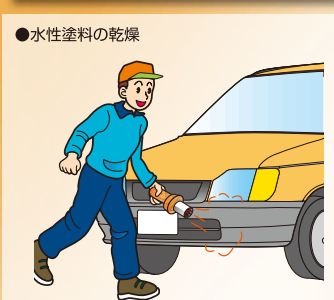
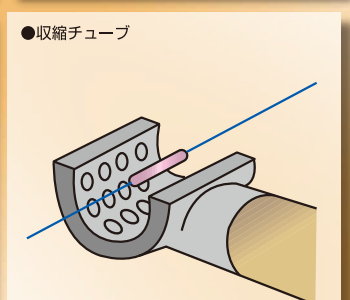
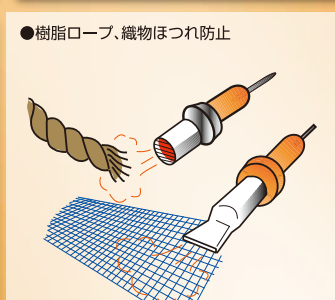
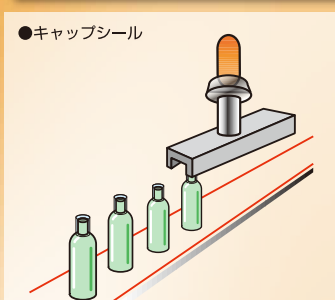
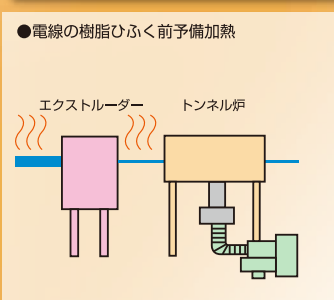
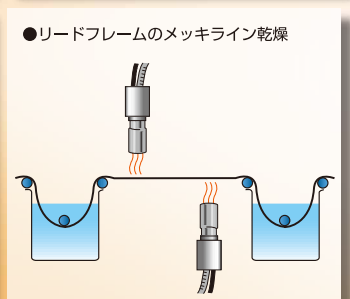
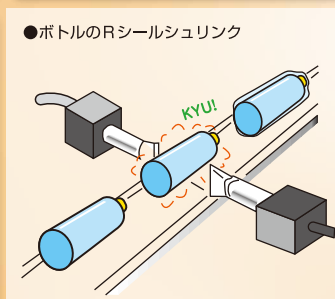
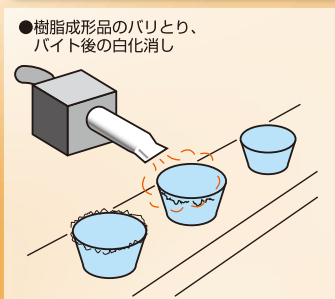
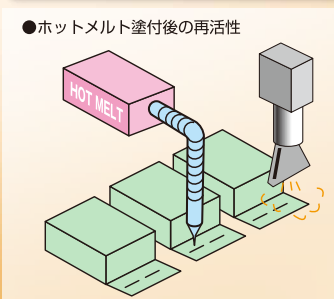
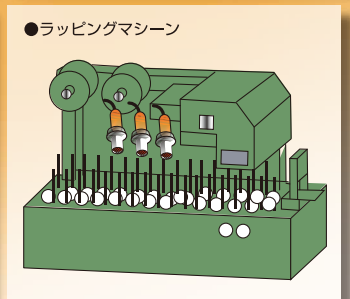
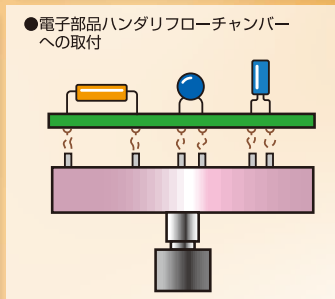
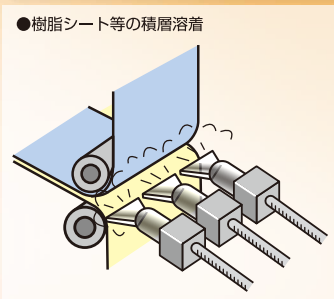
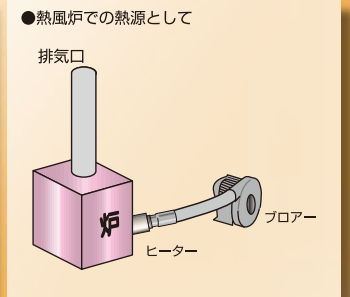
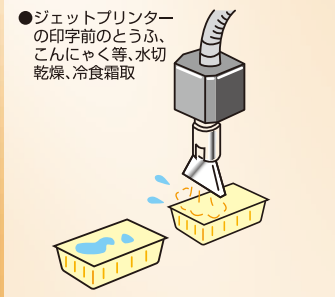
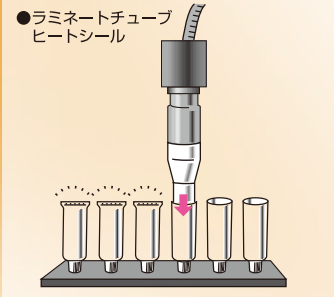

パークヒート 熱風発生機

総合カタログ



パークヒートラインアップ&送風機

パークヒートラインアップ											
	品番	電圧(V)	出力(W)	熱風温度(°C)	風量(L/分)	風圧(Pa)	モーター種類	重量(Kg)	寸法(mm)	温調	
	PHW1-1	単相100	1370	常温~650 (無段階調節可能)	230	3000	DC	1.2 (電源コード含む)	330×φ56	有	
	PHW1-2	単相200									
	PHW1-2.3	単相230									
	PHW2-2	単相200	3020	常温~650 (無段階調節可能)	500	3000	DC	1.4 (電源コード含む)	320×φ56	有	
	PHW2-2.3	単相230									
	PHW7 +7B-1	単相100	1370	常温~650 (無段階調節可能)	230	3000	DC	1.8	250×□40	有	
	PHS9-2	単相 200-230	2845 -3645	常温~650 (無段階調節可能)	155~570	350	DC	2.5 (電源コード含む)	345×92 ×130	有	
	品番	電圧(V)	出力(W)	熱風温度(°C)	吸気温度	最低必要風量(L/分)	重量(Kg)	寸法(mm)	風量調節弁	温調	
	PHW7-1	単相100	1350	常温~650 (無段階調節可能)	60°C以下	90	0.8	250×□40	有	有	
	PHW7-2	単相200									
	PHW7-2.3	単相230									
	PHW7N-2	単相200								650(MAX)	無
	PHW7N-2.3	単相230									
	PHW7NS-2	単相200	1350	650(MAX)	60°C以下	90	0.5	153×φ57	無	無	
	PHW7NS-2.3	単相230	1550								
	PHS25-2	単相	2500	常温~650	60°C以下	190-230	0.5	234×73 ×80	有	有	
	PHS25N-2	200-230	-3300	650(MAX)						無	
	PHS30-2	単相	1600	常温~650	60°C以下	120-150	0.8	228×88 ×99	有	有	
	PHS30N-2	200-230	-2100	650(MAX)						無	
	PHS30-2	単相	2700	常温~650	60°C以下	200-250				有	
	PHS30N-2	200-230	-3550	650(MAX)						無	
	PHS30N-4	単相400	4400	650(MAX)	60°C以下	280				無	
	PHS50N-2	単相200-230	3400-4500	650(MAX)	60°C以下	240-320	1.8	324×116 ×137	無	無	
			3450-4550			240-320					
		三相200-230	4950-6550			350-460					
			6000-7900			420-560					
	PHS50N-4	三相400	4650	330							
			6600	470							
8100			570								

パークヒートラインアップ			品番	電圧(V)	出力(W)	熱風温度(°C)	吸気温度	最低必要風量(L/分)	重量(Kg)	寸法(mm)	風量調節弁	温調
		PHS50NR-2	単相200-230	三相200-230	3400-4500	650(MAX)	180°C以下	240-320	1.8 (電源コードを 含まない)	324×116 ×116	無	無
					3450-4550			240-320				
			4950-6550	350-460								
			6000-7900	420-560								
		PHS50NR-4	三相400	4650	330							
				6600	470							
	8100	570										
		PHS100N-2	三相200-230	三相400	6000-7900	650(MAX)	60°C以下	420-560	2.6	300×116 ×155	無	無
					7500-9900			530-700				
					10000-13200			700-930				
		PHS100N-4	5700		400							
8100			570									
10950			770									
	PHS100NR-2	三相200-230	三相400	6000-7900	650(MAX)	180°C以下	420-560	2.6 (電源コードを 含まない)	300×116 ×116	無	無	
				7500-9900			530-700					
				10000-13200			700-930					
	PHS100NR-4	5700		400								
		8100		570								
		10950		770								

送風機			品番	電圧(V)	周波数(Hz)	最大出力(W)	最大風量(m³/分)	最大風圧(kPa)	重量(Kg)	寸法(mm)	備考		
				PHW7B-1	100	50/60	20	0.23	3.0	1 (電源コード含む)	235× φ56	カーボン ブラシレス モーター採用	
				品番	電圧(V)	周波数(Hz)	最大出力(W)	最大風量(m³/分)	最大風圧(kPa)	重量(Kg)	寸法(mm)		
					PHB202H	200	50/60	280/420	1.3/1.6	10/13	10.9	256.5×247×247	
						EC-63T	三相200	50/60	100	4.5/5.5	0.6/0.85	6.5	274×239×275

